

GRU A TORRE

GA 301 | M/T

GRU AUTOMATICA CON
MONTAGGIO IDRAULICO

GA compact



GX



GHS topless



0 - 4000 kg



TII

FBGRU
LIFT YOUR GOALS!

FB F.lli Butti s.r.l.

Via XXV Aprile, 58

23868 Valmadrera (LC) - Italia

Tel. 0341.581108 - Fax 0341.200253

E-mail : fbgru@fbgru.it - <http://www.fbgru.it>

CE

FEM 1.001 - A3
EN 14439 - C25

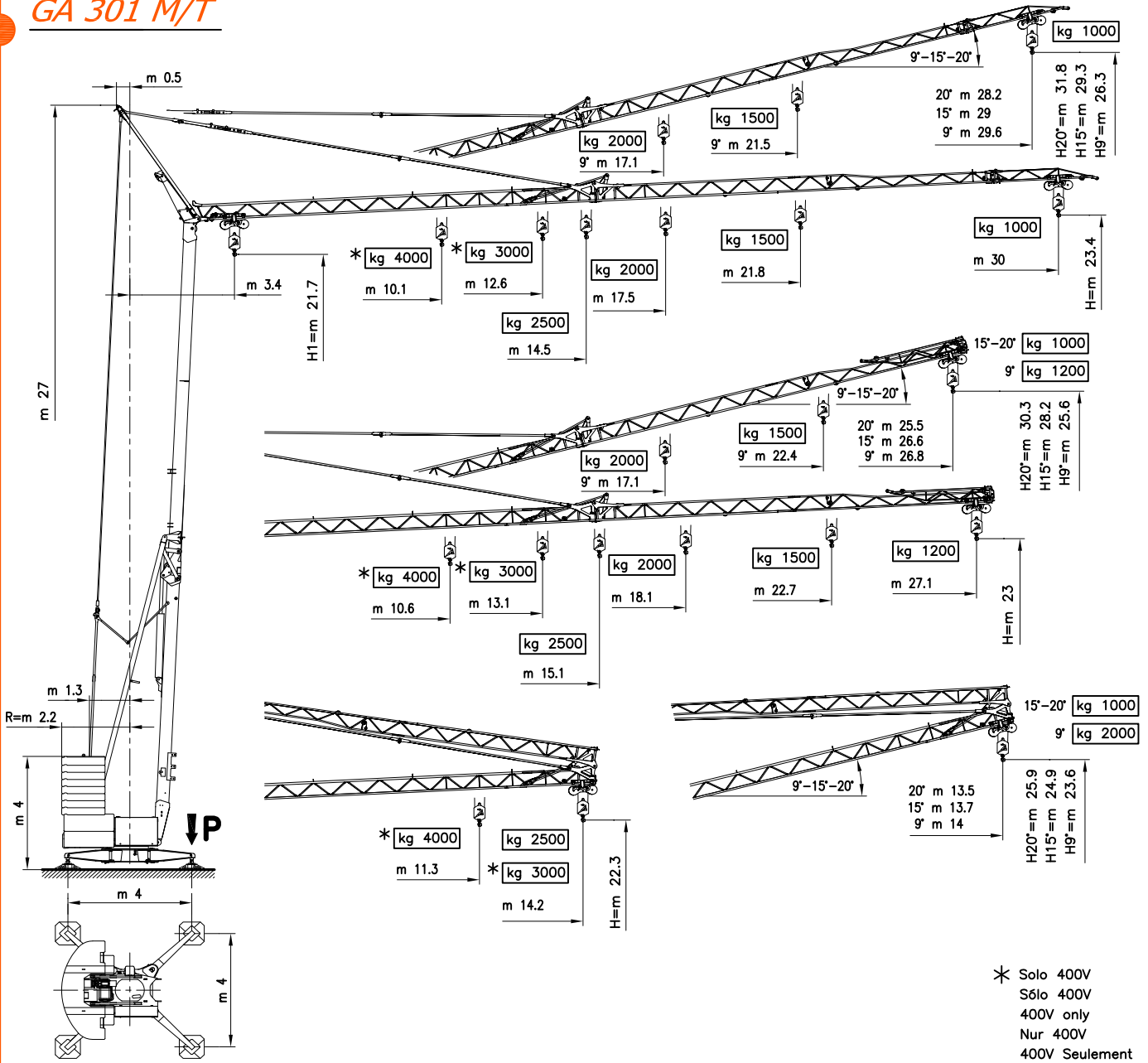

* Solo 400V
 Sólo 400V
 400V only
 Nur 400V
 400V Seulement

P	
kg 22150 <i>In servizio</i> En servicio In service In betrieb En service	kg 14450 <i>Fuori servizio</i> Fuera de servicio Out of service Außer betrieb Hors service

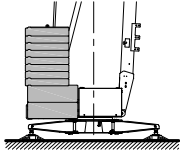
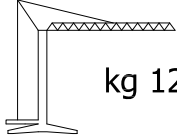
	
 N° 8x1800 N° 2x1700 N° 2x1920 kg 33770	 kg 12130

LA GRU LA GRÚA — CRANE
 KRAN — GRUE



MOVIMENTO MOVIMIENTO MOVEMENT BEWEGUNG MOUVEMENT	ALIMENTAZIONE ALIMENTACION OPERATING VOLTAGE BETRIEBSSPANNUNG TENSION DE SERVICE	PRESTAZIONI FUNCIONAMIENTOS PERFORMANCES LEISTUNGEN EXÉCUTIONS	
---	---	---	--

SOLLEVAMENTO ELEVACION – HOISTING HEBEN – LEVAGE INVERTER	 230 V 50 Hz	3 kW	1 ^a m/1' - kg	2 ^a m/1' - kg	3 ^a m/1' - kg	4 ^a m/1' - kg	5 ^a m/1' - kg	kW 15			
		4.5 kW	3	5	11	19	2500		2500	1400	600
			3	8	16	30					
		6 kW	3	11	21	38	2500		2500	1400	600
			3	18	32	46					
		400 V 50 Hz	3	18	32	46	51		4000	4000	2500
3	18		32	46	51						

CARRELLO CARRILLO – JIB TROLLEY LAUFKATZE – DISTRIBUTION INVERTER	230 V - 50 Hz 400 V - 50 Hz	1 ^a m/1'	2 ^a m/1'	3 ^a m/1'	kW 3
		20	30	45	
		20	38	61	

ROTAZIONE ROTACION – SLEWING DREHEN – ORIENTATION INVERTER	400 V 50 Hz	1 ^a g/1'	2 ^a g/1'	3 ^a g/1'	kgm 2.5
		0 → 0.14	0.14 → 0.45	0.45 → 0.93	



Conforme alle direttive
CEE sul livello acustico
2000/14/CE

Conforme con las directivas
CEE sobre el nivel acustico

In compliance with the EEC
instructions on noise level

Gemäss EWG-Richtlinien für
den Schall-Leistungspegel

Conforme aux directives CEE
sur le niveau acoustique

CURVE DI CARICO

CURVAS DE CARGAS – LOAD DIAGRAMS LASTKURVEN – COURBES DE CHARGES

V30

 0° *	m	3.4	5	8	10.1	11	12	12.6	14.5	15	17.5	18	20	21.8	22	24	26	28	30
	kg	2500								2405	2000	1910	1673	1500	1484	1330	1201	1093	1000
	kg	4000			3590	3203	3000	2500	2405	2000	1910	1673	1500	1484	1330	1201	1093	1000	
 9°	m	3.4	5	8	10	12	14	16	17.1	18	19	20	21	21.5	22	24	26	28	29.6
	kg	2000								1882	1759	1649	1550	1500	1462	1310	1183	1076	1000
 15°	m	3.4	5	10	15	20	25	29											
	kg	1000																	
 20°	m	3.4	5	10	15	20	25	28.2											
	kg	1000																	

* Solo 400V
Sólo 400V
400V only
Nur 400V
400V Seulement

POTENZA RICHIESTA

POTENCIA-ELECTRICA NECESARIA – NECESSARY ELECTRIC POWER KRAFTBEDARF – PUISSANCE ELECTRIQUE NECESSAIRE

	3 kW	4.5 kW	6 kW	14 kW
	230 V - 50 Hz	230 V - 50 Hz	230 V - 50 Hz	400 V - 50 Hz

TRASPORTO TRANSPORTE — TRANSPORT
TRANSPORT — TRANSPORT

5
km/h

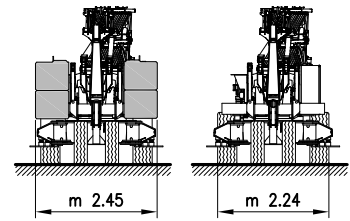
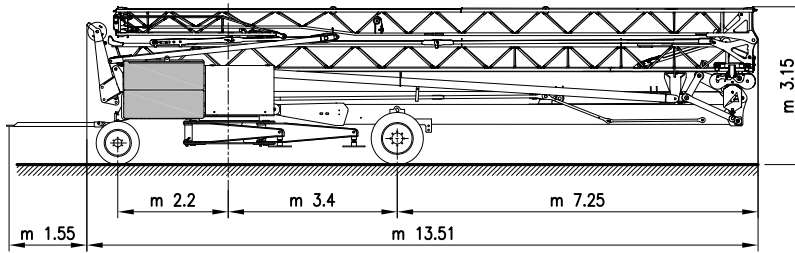

FB25K1

25
km/h

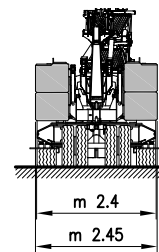
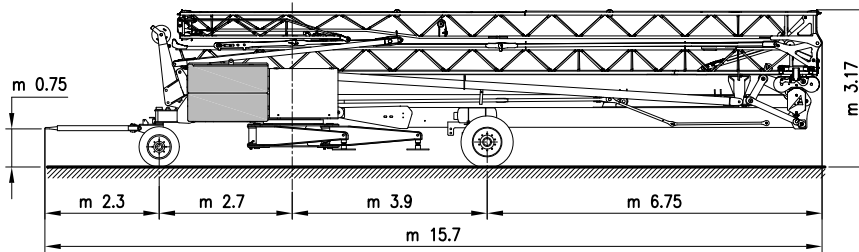

MONTAGGIO MONTAJE — ERECTION
MONTAGE — MONTAGE

