

GRU A TORRE

GA 138

GRU AUTOMATICA CON
MONTAGGIO IDRAULICO

GA compact



GX



GHS topless



FBGRU
LIFT YOUR GOALS!

FB F.lli Butti s.r.l.

Via XXV Aprile, 58

23868 Valmadrera (LC) - Italia

Tel. 0341.581108 - Fax 0341.200253

E-mail : fbgru@fbgru.it - <http://www.fbgru.it>

CE

FEM 1.001 - A3
EN 14439 - C25

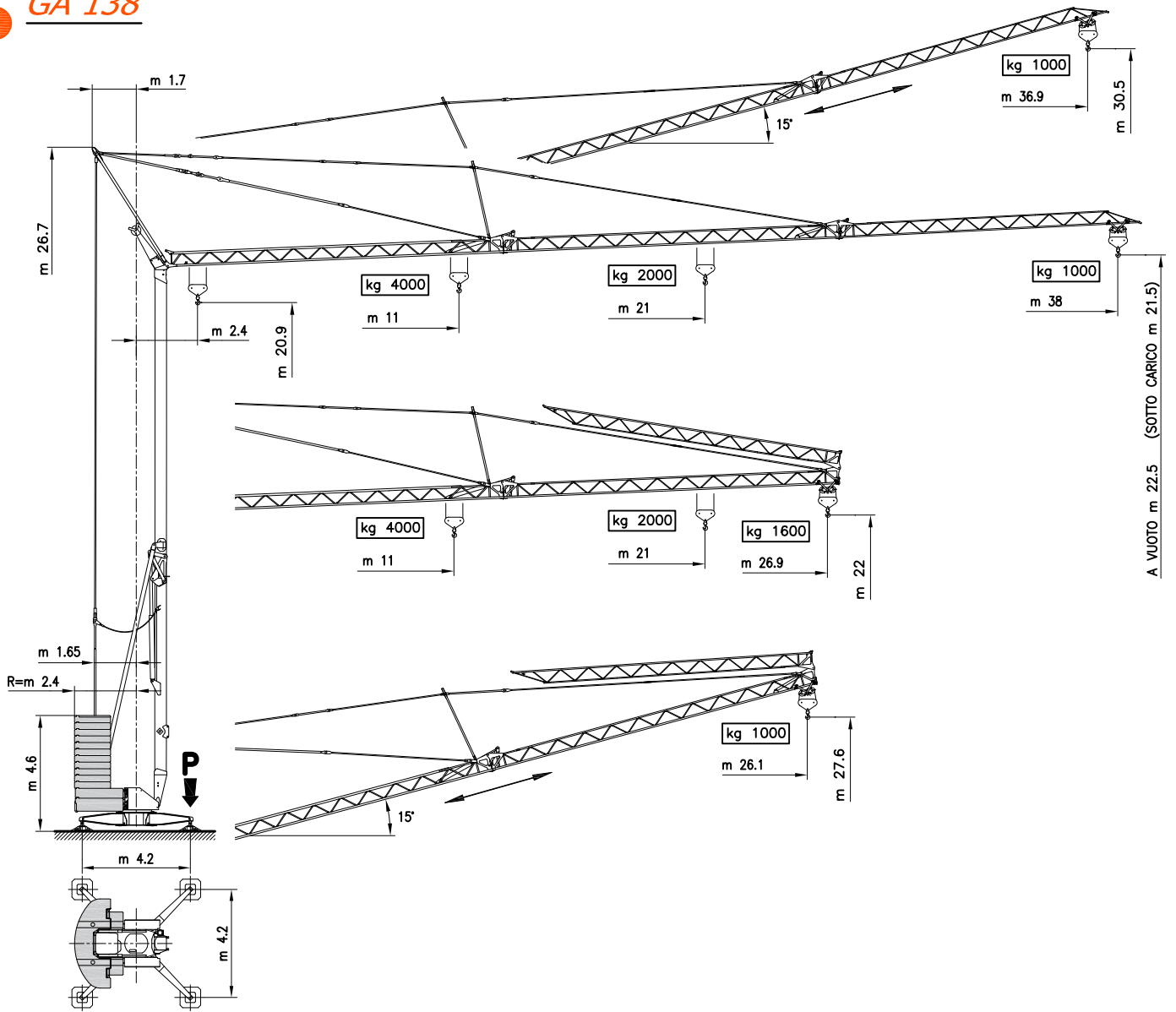



P	
kg 26100	kg 19400
<i>In servizio</i>	<i>Fuori servizio</i>
En servicio	Fuera de servicio
In service	Out of service
In betrieb	Außer betrieb
En service	Hors service

	N° 11x1800 N° 2x1850 N° 2x1550 kg 40750	 kg 14150

LA GRU LA GRÚA — CRANE
KLAN — GRUE



MOVIMENTO MOVIMIENTO MOVEMENT BEWEGUNG MOUVEMENT	ALIMENTAZIONE ALIMENTACION OPERATING VOLTAGE BETRIEBSSPANNUNG TENSION DE SERVICE	PRESTAZIONI FUNCIONAMIENTOS PERFORMANCES LEISTUNGEN EXÉCUTIONS	
---	---	---	---

SOLLEVAMENTO ELEVACION – HOISTING HEBEN – LEVAGE  INVERTER	400 V 50 Hz		1 ^a m/1' - kg	2 ^a m/1' - kg	3 ^a m/1' - kg	4 ^a m/1' - kg	kW 15
			4	16	34	46	
			4000	4000	2000	1000	

CARRELLO CARRILLO – JIB TROLLEY LAUFKATZE – DISTRIBUTION  INVERTER	400 V 50 Hz	1 ^a m/1'	2 ^a m/1'	3 ^a m/1'	kW 3
		18	30	56	

ROTAZIONE ROTACION – SLEWING DREHEN – ORIENTATION  INVERTER	400 V 50 Hz	1 ^a g/1'	2 ^a g/1'	3 ^a g/1'	kW 3
		0 → 0.15	0.15 → 0.6	0.6 → 0.85	



Conforme alle direttive
CEE sul livello acustico
2000/14/CE

Conforme con las directivas
CEE sobre el nivel acustico

In compliance with the EEC
instructions on noise level

Gemäss EWG-Richtlinien für
den Schall-Leistungspegel

Conforme aux directives CEE
sur le niveau acoustique

CURVE DI CARICO

CURVAS DE CARGAS – LOAD DIAGRAMS LASTKURVEN – COURBES DE CHARGES

V38 

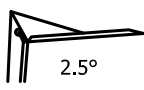
 2.5°	m	2.4	7	11	12.5	14	16	18	20	21	22	24	26.9	28	30	32	34	36	38
	kg	4000			3745	3289	2815	2454	2169	2000	1924	1750	1527	1456	1339	1238	1149	1070	1000

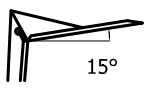

 15°	m	2.4	5	8	11	14	17	19	20	23	26	29	32	35	38
	kg	1000													

(0 - 4000 kg)

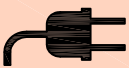

POTENZA RICHIESTA

POTENCIA-ELECTRICA NECESARIA – NECESSARY ELECTRIC POWER KRAFTBEDARF – PUISSANCE ELECTRIQUE NECESSAIRE

	SOLLEVAMENTO ELEVACION – HOISTING – HEBEN – LEVAGE	 kg 4000
	14 kw 400 V - 50 Hz	

TRASPORTO TRANSPORTE — TRANSPORT
TRANSPORT — TRANSPORT

5
km/h

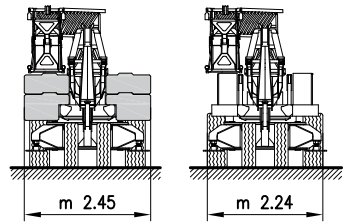
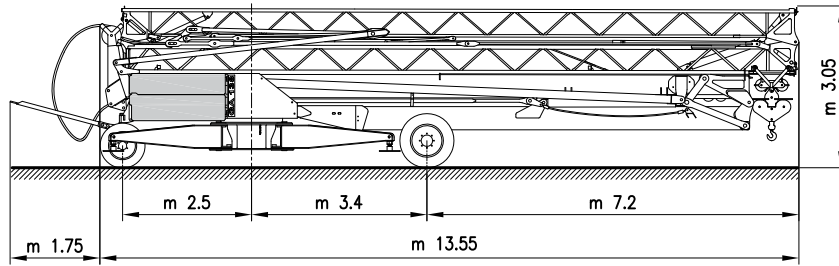

FB25K1

25
km/h

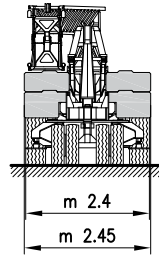
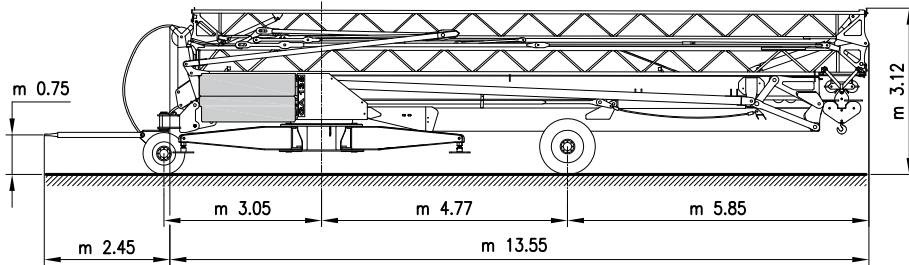

MONTAGGIO MONTAJE — ERECTION
MONTAGE — MONTAGE

